

Needle Valve

Low Pressure, Single Ferrule 15,000 psi (1034 bar)

10V2 and SW Series (“SpeedBite”)



Principle of Operation:

The Low Pressure (15,000 psi maximum), otherwise known as “SpeedBite” Needle Valves are designed for applications between traditional compression fittings and the Parker Autoclave Engineers’ Medium Pressure Cone and Thread products that are designed for high flow and high pressure. SpeedBite Valves are engineered for use with annealed ASTM A269 316 (and similar) Stainless Steel tubing designed by Parker Autoclave Engineers to a controlled hardness. SpeedBite valves employ a bite-type compression style single ferrule that is manually “set”. 1-1/4 rotation from tube grip forces the ferrule into tapered seat and causes the leading edge of ferrule to bite into the tubing, creating a shoulder for positive mechanical support of the tubing. When correctly installed, connection strength far exceeds the burst pressure of the tubing utilized.

Low Pressure Valve Features:

Temperature Rated -100°F (-73°C) to 650°F (343°C)

- Designed for use with Low Pressure “SpeedBite” single ferrule compression fittings and tubing
- 10V2 Series valve design provides for a 1/8" tube size connection
- SW Series valves are constructed for tube sizes from 1/4" to 1/2" OD
- UNS S31600 cold worked 316 SS body construction as standard. (Optional materials available)
- Non-rotating stem prevents stem/seat galling
- Metal-to-metal seating achieves bubble-tight shut-off, longer stem/seat life, greater durability for repeated on/off cycles and excellent corrosion resistance. These valves can be used with liquid and gas.
- PTFE packing below stem threads provides dependable stem and body sealing. Optional packing materials available.
- Choice of Vee (Shutoff) or Regulating (Flow Control) stem tips
- Optional N-Dura Stem and/or Replaceable Seat Coating or Stellite material option for severe service available
- Available in five body patterns

Traceability is ensured by use of heat and purchase order codes etched on valve body that also includes model number, MAWP rating, and material type references. All valves include compression sleeve and gland nut unless requested otherwise. Parker Autoclave Engineers’ valves are complemented by a complete line of low pressure fittings, tubing, check valves, relief valves, and line filters.

All Parker Autoclave Engineers products are designed in accordance with ASME B31.3 Chapter IX High Pressure Piping standards.



ENGINEERING YOUR SUCCESS.

10V2 and SW Series: Pressures to 15,000 psi (1034 bar)



Tube Outside Diameter Size (inches)	Connection Type	Orifice Size Inches (mm)	Rated C_V^*	Pressure Rating psi (bar) @Room Temperature**
1/8 (10V2 Series)	W125	0.094 (2.39)	0.12	15,000 (1034)
1/4	SW250	0.188 (4.77)	0.65	15,000 (1034)
3/8	SW375	0.250 (6.35)	0.95	15,000 (1034)
1/2	SW500	0.375 (9.52)	1.90	10,000 (690)

Notes

* C_V values shown are for 2-way straight valve pattern. For 2-way angle patterns, increase C_V value 50%.

** Maximum Allowable Working Pressures decrease as temperatures increase see pressure/temperature rating guide in Technical Information section.

Formula for converting C_V to volumetric flow can be found in Technical Information section

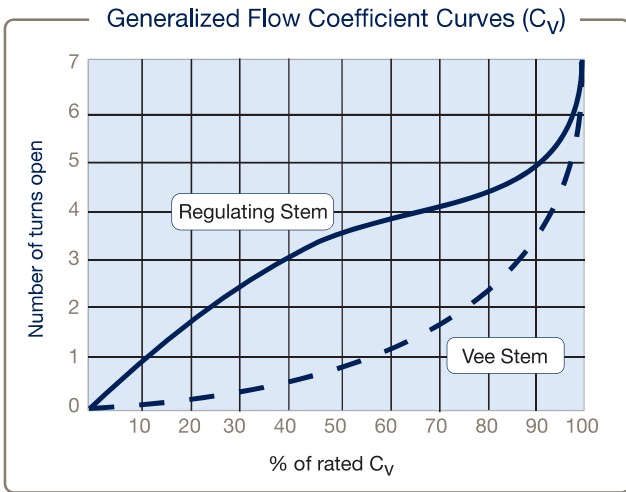

10V2 and SW Series Flow Curve for Vee and Regulating Stem Valves

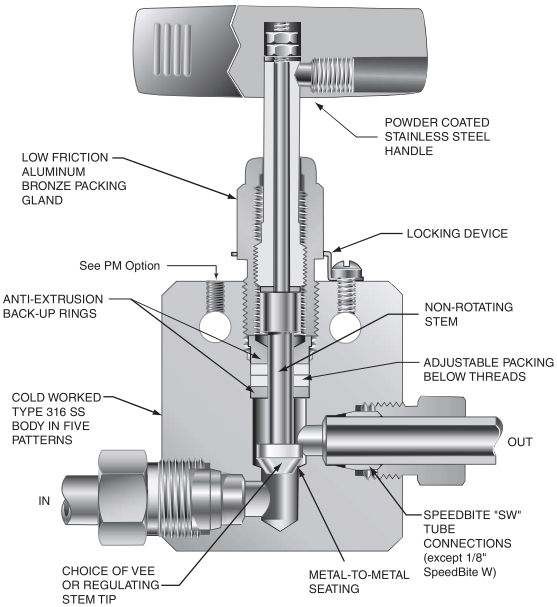

To ensure proper fit use Parker Autoclave tubing

Valve Packing Options:

Standard Parker Autoclave valves with PTFE packing may be operated from 0° (-18°C) to 450°F (232°C). Extreme temperature packing for service from -100°F (-73°C) to 650°F (343°C) by adding the following suffixes to catalog order number.†

B Cryogenic trim materials and PTFE required when below 0°F (-18°C) -100°F (-73°C).

TG Standard valve with PTFE glass packing -100°F (-73°C) to 600°F (316°C). (See also -B option above when below 0°F (-18°C)

GY Standard valve with Graphite Yarn packing to 650°F (343°C).

† Parker Autoclave Engineers does not recommend compression sleeve connections below -100°F (-73°C) or above 650°F (343°C). For additional valve options, contact your Sales Representative. (See "Technical Brochure" for Pressure/Temperature effect on temperatures above ambient.)

Ordering Guide:

Common valve option details can be found on pages 6 & 7. The part number and option ordering matrix is given below. 10V/SW Series "SpeedBite" valves are furnished complete with connection components, unless otherwise specified.

Building a Part Number: <i>Example: SW4071</i>						
Example Part Number:	SW	4	07	1	-	XX
Ordering Parameters/Options:	Valve Series	Outside Diameter Tube Size	Stem/Seat Type	Body Pattern		Options
Table Reference: (see below)	A	B	C	D		E

A - Valve Series	
10V	Low Pressure Needle Valve (1/8" Tube Size only)
SW	Low Pressure Needle Valve

B - Outside Diameter Tube Size	
2	1/8" (10V only)
4	1/4"
6	3/8"
8	1/2" (10,000 psi maximum)

C - Stem/Seal Type (see page 6 for optional Stem Types)	
07	Non-Rotating Vee Stem (on-off service)
08	Non-Rotating Regulating Stem (tapered tip for regulating and shutoff)
87	Vee Stem with Replaceable Seat
88	Regulating Stem with Replaceable Seat

Notes:
Valve Manuals can be found on our website at www.Autoclave.com. Connection, Running and Seating Torques can be found in the product manual or in our Tools and Installation Catalog Section

Valves that have not been cycled for a substantial period of time may require higher initial actuation torque.

Speedbite connections are set by making 1-1/4 turns from WRENCH tight (point beyond finger tight where torque to tighten suddenly increases and sleeve begins to grip tubing.) Installation instructions can be found in Tools & Installation brochure.

*Replaceable seat option is sold with two (2) seat surfaces 180° apart.

D - Body Pattern	
1	Two-Way Straight
2	Two-Way Angle
3	Three-Way, Two on Pressure
4	Three-Way, One on Pressure
5	Three-Way, Two Stem Manifold Valve

E - Options (choose as many as necessary)	
For additional valve options see pages 6-7 or contact factory.	
B	All 316 SS materials required when below 0°F (-18°C)
TG	PTFE Glass (25%) Packing (to 600°F)
GY	Graphite Packing (to 650°F)
HC	Hastelloy C-276***
MO	Monel***

Note: Contact factory for 1/16" tube size or see MVE Series. Pneumatic and electric actuators are available for these valves, see associated brochures for details.

316 SS valve bodies are cold worked and not suitable for use in NACE (ISO 15156) applications. If required, contact factory for options.

*** Special Materials often have reduced MAWP ratings, see Technical brochure for assistance and for additional material options.

(See "Technical Brochure" for Pressure/Temperature effect on temperatures above ambient.)

Basic Repair Kits for 316 SS Material:

Stem Type		Basic Repair Kit for 316 SS Material			
		Outside Diameter Tube:			
		1/8" (10V2 Series)	1/4"	3/8"	1/2"
2 Way Straight / 2 Way Angle / 3 Way	VEE	R10V207	RSW407	RSW607	RSW807
	REG	R10V208	RSW408	RSW608	RSW808
2 Way, Replaceable Seat and Stem	VEE	R10V2872	RSW4872	RSW6872	RSW8872
	REG	R10V2882	RSW4882	RSW6882	RSW8882
3 Way, 2 Stem Manifold	VEE	R10V2075	RSW4075	RSW6075	RSW8075
	REG	R10V2085	RSW4085	RSW6085	RSW8085
When ordering for valves bought with additional suffix options, please include those exact suffix codes when ordering repair kit. (Example: the stem for a manual valve is manufactured differently for a pneumatically actuated valve and the repair kit must include the exact actuator suffix codes). Valve Manuals can be found on our website at www.Autoclave.com . Connection, Running and Seating Torques can be found in the product manual or in our Tools and Installation Catalog Section					

10V2 and SW Series Dimensions:

2 Way Straight						
		Catalog Number				
Stem Type	VEE REG	10V2071 10V2081	SW4071 SW4081	SW6071 SW6081	SW8071 SW8081	
Outside Diameter Tube		1/8 (3.18)	1/4 (6.35)	3/8 (6.35)	1/2 (12.70)	
Orifice Diameter		0.094 (2.39)	0.187 (4.75)	0.250 (3.18)	0.375 (9.53)	
Dimensions: inches (mm)						
		A	1.50 (38.10)	2.00 (50.80)	2.00 (50.80)	2.50 (63.50)
		B	0.75 (19.05)	1.00 (25.40)	1.00 (25.40)	1.25 (31.75)
		C	0.31 (7.87)	0.38 (9.65)	0.47 (11.94)	0.53 (13.46)
		D	1.06 (26.92)	1.62 (41.15)	1.62 (41.15)	2.38 (60.45)
		D1	0.81 (20.57)	1.19 (30.23)	1.19 (30.23)	1.75 (44.45)
		E	1.38 (35.05)	2.00 (50.80)	2.00 (50.80)	2.88 (73.15)
		F	3.00 (76.20)	3.00 (76.20)	3.00 (76.20)	4.00 (101.60)
		G	0.62 (15.79)	0.75 (19.05)	0.75 (19.05)	1.00 (25.40)
		G1	0.17 (4.32)	0.22 (5.59)	0.22 (5.59)	0.34 (8.64)
		H*	3.75 (95.25)	4.50 (114.30)	4.50 (114.30)	5.95 (151.37)
		M	0.56 (14.22)	0.62 (15.75)	0.62 (15.75)	0.69 (17.53)
		N	0.31 (7.87)	0.38 (9.65)	0.38 (9.65)	0.50 (12.70)
Block Thickness			0.62 (15.75)	0.75 (19.05)	0.75 (19.05)	1.00 (25.40)

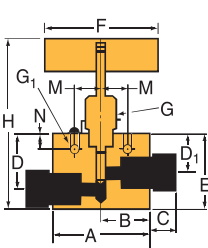

2 Way Angle						
		Catalog Number				
Stem Type	VEE REG	10V2072 10V2082	SW4072 SW4082	SW6072 SW6082	SW8072 SW8082	
Outside Diameter Tube		1/8 (3.18)	1/4 (6.35)	3/8 (6.35)	1/2 (12.70)	
Orifice Diameter		0.094 (2.39)	0.187 (4.75)	0.250 (3.18)	0.375 (9.53)	
Dimensions: inches (mm)						
		A	1.50 (38.10)	2.00 (50.80)	2.00 (50.80)	2.50 (63.50)
		B	0.75 (19.05)	1.00 (25.40)	1.00 (25.40)	1.25 (31.75)
		C	0.31 (7.87)	0.38 (9.65)	0.47 (11.94)	0.53 (13.46)
		D	0.81 (20.57)	1.19 (30.23)	1.19 (30.23)	1.75 (44.45)
		D1	NA			
		E	1.56 (39.62)	2.43 (61.72)	2.19 (55.63)	3.38 (85.85)
		F	3.00 (76.20)	3.00 (76.20)	3.00 (76.20)	4.00 (101.60)
		G	0.62 (15.79)	0.75 (19.05)	0.75 (19.05)	1.00 (25.40)
		G1	0.17 (4.32)	0.22 (5.59)	0.22 (5.59)	0.34 (8.64)
		H*	3.94 (100.08)	5.00 (127.00)	5.00 (127.00)	6.45 (163.83)
		M	0.56 (14.22)	0.62 (15.75)	0.62 (15.75)	0.69 (17.53)
		N	0.31 (7.87)	0.38 (9.65)	0.38 (9.65)	0.50 (12.70)
Block Thickness			0.62 (15.75)	0.75 (19.05)	0.75 (19.05)	1.00 (25.40)

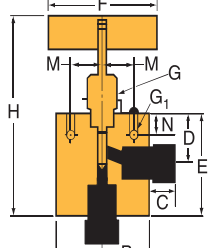

3 Way, 2 on Pressure						
		Catalog Number				
Stem Type	VEE REG	10V2073 10V2083	SW4073 SW4083	SW6073 SW6083	SW8073 SW8083	
Outside Diameter Tube		1/8 (3.18)	1/4 (6.35)	3/8 (6.35)	1/2 (12.70)	
Orifice Diameter		0.094 (2.39)	0.187 (4.75)	0.250 (3.18)	0.375 (9.53)	
Dimensions: inches (mm)						
		A	1.50 (38.10)	2.00 (50.80)	2.00 (50.80)	2.50 (63.50)
		B	0.75 (19.05)	1.00 (25.40)	1.00 (25.40)	1.25 (31.75)
		C	0.31 (7.87)	0.38 (9.65)	0.47 (11.94)	0.53 (13.46)
		D	1.06 (26.92)	1.62 (41.15)	1.62 (41.15)	2.38 (60.45)
		D1	0.81 (20.57)	1.19 (30.23)	1.19 (30.23)	1.75 (44.45)
		E	1.69 (42.93)	2.62 (66.55)	2.62 (66.55)	3.62 (91.95)
		F	3.00 (76.20)	3.00 (76.20)	3.00 (76.20)	4.00 (101.60)
		G	0.62 (15.79)	0.75 (19.05)	0.75 (19.05)	1.00 (25.40)
		G1	0.17 (4.32)	0.22 (5.59)	0.22 (5.59)	0.34 (8.64)
		H*	4.06 (103.12)	5.18 (131.57)	5.13 (130.30)	6.70 (170.18)
		M	0.56 (14.22)	0.62 (15.75)	0.62 (15.75)	0.69 (17.53)
		N	0.31 (7.87)	0.38 (9.65)	0.38 (9.65)	0.50 (12.70)
Block Thickness			0.62 (15.75)	0.75 (19.05)	0.75 (19.05)	1.00 (25.40)

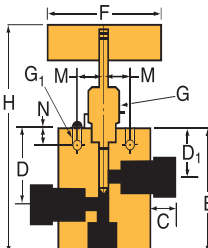

3 Way, 1 on Pressure						
		Catalog Number				
Stem Type	VEE REG	10V2074 10V2084	SW4074 SW4084	SW6074 SW6084	SW8074 SW8084	
Outside Diameter Tube		1/8 (3.18)	1/4 (6.35)	3/8 (6.35)	1/2 (12.70)	
Orifice Diameter		0.094 (2.39)	0.187 (4.75)	0.250 (3.18)	0.375 (9.53)	
Dimensions: inches (mm)						
		A	1.50 (38.10)	2.00 (50.80)	2.00 (50.80)	2.50 (63.50)
		B	0.75 (19.05)	1.00 (25.40)	1.00 (25.40)	1.25 (31.75)
		C	0.31 (7.87)	0.38 (9.65)	0.47 (11.94)	0.53 (13.46)
		D	0.81 (20.57)	1.19 (30.23)	1.19 (30.23)	1.75 (44.45)
		D1	NA			
		E	1.55 (39.62)	2.43 (61.72)	2.43 (61.72)	3.38 (85.85)
		F	3.00 (76.20)	3.00 (76.20)	3.00 (76.20)	4.00 (101.60)
		G	0.62 (15.79)	0.75 (19.05)	0.75 (19.05)	1.00 (25.40)
		G1	0.17 (4.32)	0.22 (5.59)	0.22 (5.59)	0.34 (8.64)
		H*	3.94 (100.08)	5.00 (127.00)	5.00 (127.00)	6.45 (163.83)
		M	0.56 (14.22)	0.62 (15.75)	0.62 (15.75)	0.69 (17.53)
		N	0.31 (7.87)	0.38 (9.65)	0.38 (9.65)	0.50 (12.70)
Block Thickness			0.62 (15.75)	0.75 (19.05)	0.75 (19.05)	1.00 (25.40)

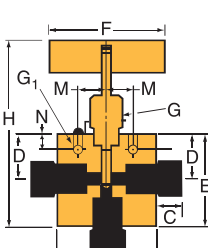

G - Packing Gland mounting hole drill size • G1 - Bracket mounting hole size • H* - Dimension is with stem in closed position
All dimensions for reference only and subject to change • For prompt service, Parker Autoclave stocks select products. Consult factory.

10V2 and SW Series Dimensions:

2 Way Angle / Replacable Seat					
		Catalog Number			
Stem Type	VEE REG	10V2872 10V2882	SW4872 SW4882	SW6872 SW6882	SW8872 SW8882
Outside Diameter Tube		1/8 (3.18)	1/4 (6.35)	3/8 (6.35)	1/2 (12.70)
Orifice Diameter		0.094 (2.39)	0.187 (4.75)	0.250 (3.18)	0.375 (9.53)
Dimensions: inches (mm)					
	A	1.50 (38.10)	2.00 (50.80)	2.00 (50.80)	2.50 (63.50)
	B	0.75 (19.05)	1.00 (25.40)	1.00 (25.40)	1.25 (31.75)
	C	0.31 (7.87)	0.38 (9.65)	0.47 (11.94)	0.53 (13.46)
	D	0.81 (20.57)	1.19 (31.32)	1.19 (31.32)	1.75 (44.45)
	D1	1.28 (32.51)	1.88 (47.75)	2.19 (55.62)	2.50 (63.50)
	E	1.56 (39.62)	2.25 (57.15)	2.25 (57.15)	3.25 (82.55)
	F	3.00 (76.20)	3.00 (76.20)	3.00 (76.20)	4.00 (101.60)
	G	0.62 (15.79)	0.75 (19.05)	0.75 (19.05)	1.00 (25.40)
	G1	0.17 (4.32)	0.22 (5.59)	0.22 (5.59)	0.34 (8.64)
	H*	4.50 (114.30)	5.75 (146.05)	5.75 (146.05)	7.51 (190.75)
	M	0.56 (14.22)	0.62 (15.75)	0.62 (15.75)	0.69 (17.53)
	N	0.31 (7.87)	0.38 (9.65)	0.38 (9.65)	0.50 (12.70)
Block Thickness		0.62 (15.75)	0.75 (19.05)	0.75 (19.05)	1.00 (25.40)

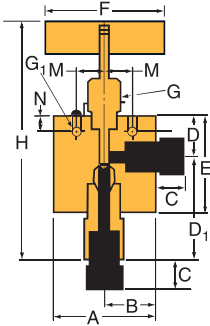

3 Way, 2 Stem Manifold					
		Catalog Number			
Stem Type	VEE REG	10V2075 10V2085	SW4075 SW4085	SW6075 SW6085	SW8075 SW8085
Outside Diameter Tube		1/8 (3.18)	1/4 (6.35)	3/8 (6.35)	1/2 (12.70)
Orifice Diameter		0.094 (2.39)	0.187 (4.75)	0.250 (3.18)	0.375 (9.53)
Dimensions: inches (mm)					
	A	1.50 (38.10)	2.00 (50.80)	2.00 (50.80)	2.50 (63.50)
	B	0.75 (19.05)	1.00 (25.40)	1.00 (25.40)	1.25 (31.75)
	C	0.31 (7.87)	0.38 (9.65)	0.47 (11.94)	0.53 (13.46)
	D	1.12 (28.45)	1.68 (42.67)	1.68 (42.67)	2.56 (65.02)
	D1	0.81 (20.57)	1.19 (30.23)	1.19 (30.23)	1.75 (44.45)
	E	2.25 (57.15)	3.38 (85.85)	3.38 (85.85)	5.12 (130.05)
	F	3.00 (76.20)	3.00 (76.20)	3.00 (76.20)	4.00 (101.60)
	G	0.62 (15.79)	0.75 (19.05)	0.75 (19.05)	1.00 (25.40)
	G1	0.17 (4.32)	0.22 (5.59)	0.22 (5.59)	0.34 (8.64)
	H*	4.63 (117.60)	5.94 (150.88)	5.94 (150.88)	8.20 (208.28)
	M	0.56 (14.22)	0.62 (15.75)	0.62 (15.75)	0.69 (17.53)
	N	0.31 (7.87)	0.38 (9.65)	0.38 (9.65)	0.50 (12.70)
Block Thickness		0.62 (15.75)	0.75 (19.05)	0.75 (19.05)	1.00 (25.40)

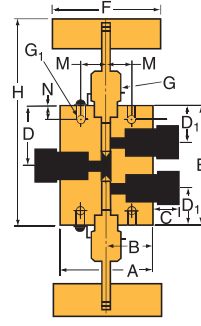

G - Packing Gland mounting hole drill size • G1 - Bracket mounting hole size • H* - Dimension is with stem in closed position
All dimensions for reference only and subject to change • For prompt service, Parker Autoclave stocks select products. Consult factory.

Material of Construction:

Item #	Description	Material
1	Hex Nut	300 Series SS
2	Thrust Washer	17-4 PH
3	Stem Sleeve	304 SS
4	Vee Stem (3/8" SW shown)	316 SS
5	Packing Gland	AMPCO 18
6	Thrust Washer	17-4 PH
7	Packing Washer	AMPCO 45
8	Bottom Washer	316 SS
9	Handle Assembly	316 SS
10	Fill HD Screw, #10-24	18-8 SS
11	Locking Device	302 SS
12	Packing	PTFE
13	Valve Body, (3/8" SW shown)	CW 316/316L SS
•	Replaceable Seat	17-4 PH

Typical spare parts found in Repair Kits (• indicates part not shown)

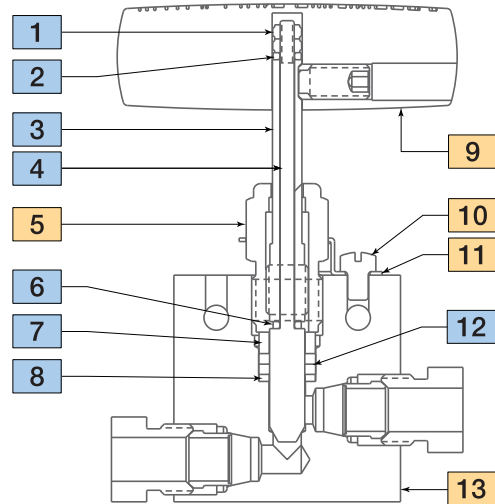

Panel Hole Sizes:

Valve Size	Inches			
	A	B	Screw Size	G
10V2	1.12	.22	#10-24	.62
4 and 6	1.25	.22	#10-24	.75
8	1.375	.22	#10-24	1.00

Use suffix -PM for extra mounting hardware

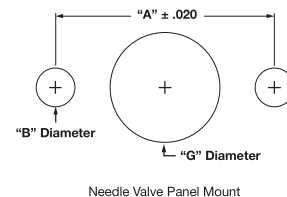

Needle Valve Panel Mount